

FEATURES

Conversion gain: 11 dB (typical) at $IF_{OUT} = 100$ MHz
Image rejection: 25 dB (typical) at $IF_{OUT} = 100$ MHz
LO to RF isolation: 46 dB (typical)
LO to IF isolation: 26 dB (typical)
IF output frequency: dc to 3.5 GHz
32-lead, 4.9 mm × 4.9 mm ceramic leadless chip carrier

APPLICATIONS

Point to point radios
Point to multipoint radios and very small aperture terminals (VSATs)
Test equipment and sensors
Military end use

GENERAL DESCRIPTION

The HMC908A is a compact, gallium arsenide (GaAs), monolithic microwave integrated circuit (MMIC), inphase/quadrature (I/Q) downconverter in a leadless, RoHS compliant ceramic leadless chip carrier. This device provides a small signal conversion gain of 11 dB with a noise figure of 2 dB and 25 dB of image rejection at 100 MHz. The HMC908A utilizes a low noise amplifier (LNA) followed by an image rejection mixer that is driven by a local oscillator (LO) buffer amplifier. The

FUNCTIONAL BLOCK DIAGRAM

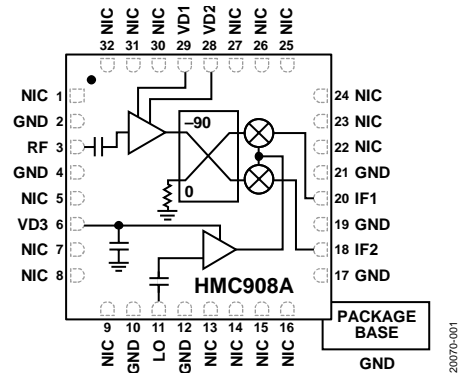

Figure 1.

image rejection mixer eliminates the need for a filter following the LNA, and removes thermal noise at the image frequency. I and Q mixer outputs are provided and an external 90° hybrid is needed to select the required sideband. The HMC908A is a much smaller alternative to hybrid style image rejection mixer downconverter assemblies, and it eliminates the need for wire bonding by allowing the use of surface-mount manufacturing techniques.

TABLE OF CONTENTS

Features	1	Downconverter Performance: $IF_{OUT} = 3500$ MHz, Lower Sideband (High-Side LO).....	11
Applications.....	1	Downconverter Performance: IF Bandwidth, Upper Sideband (Low-Side LO)	13
Functional Block Diagram	1	Downconverter Performance: IF Bandwidth, Lower Sideband (High-Side LO)	16
General Description	1	Amplitude/Phase Balance, Downconverter.....	19
Revision History	2	Isolation and Return Loss	20
Specifications.....	3	Spurious Output Performance.....	21
Absolute Maximum Ratings.....	4	Theory of Operation	22
Solder Profile.....	4	LO Driver Amplifier	22
Thermal Resistance	4	Mixer.....	22
ESD Caution.....	4	LNA	22
Pin Configuration and Function Descriptions.....	5	Applications Information	23
Interface Schematics.....	5	Layout	23
Typical Performance Characteristics	6	Performance at Lower IF Frequencies.....	25
Downconverter Performance: $IF_{OUT} = 100$ MHz, Upper Sideband (Low-Side LO)	6	Outline Dimensions	26
Downconverter Performance: $IF_{OUT} = 100$ MHz, Lower Sideband (High-Side LO).....	8	Ordering Guide	26
Downconverter Performance: $IF_{OUT} = 3500$ MHz, Upper Sideband (Low-Side LO)	9		

REVISION HISTORY

4/2019—Revision 0: Initial Version

SPECIFICATIONS

$T_A = 25^\circ\text{C}$, LO drive level = 0 dBm, $VD1 = VD2 = 3\text{ V}$, $VD3 = 5\text{ V}$. All measurements performed on the evaluation printed circuit board (PCB).

Table 1.

Parameter	Test Conditions/Comments	Min	Typ	Max	Unit
FREQUENCY					
Radio Frequency (RF)		9		12	GHz
Intermediate Frequency (IF) Output		DC		3.5	GHz
LO Input		8.5		15.5	GHz
LO DRIVE LEVEL					
		-4	0	+6	dBm
RF PERFORMANCE					
Downconverter (IF_{OUT}), $IF_{OUT} = 100\text{ MHz}$	Upper sideband				
Conversion Gain		8	11		dB
Image Rejection		15	25		dB
Input Third-Order Intercept (IP3)		-3	0		dBm
Input Second-Order Intercept (IP2)			31		
Input 1 dB Compression Point (P1dB)			-8		dBm
Noise Figure			2	3.5	dB
Downconverter (IF_{OUT}), $IF_{OUT} = 3500\text{ MHz}$	Lower sideband				
Conversion Gain		7	9		dB
Image Rejection		18	30		dB
Input IP3		-3	+1		dBm
Input IP2			27		
Input P1dB			-9		dBm
Noise Figure			3		dB
Amplitude Balance	Taken without external 90° hybrid		± 1		dB
Phase Balance	Taken without external 90° hybrid		± 6		Degrees
Isolation	Taken without external 90° hybrid				
LO to RF		36	46		dB
LO to IF		17	26		dB
RF to IF			5		dB
Return Loss	Taken without external 90° hybrid				
LO			12		dB
RF			18		dB
IF1			12		dB
IF2			10		dB
SUPPLIES					
Supply Current of RF LNA ($I_{D1} + I_{D2}$)	$VD1 = VD2 = 3\text{ V}$		53	85	mA
Supply Current of LO Amplifier (I_{D3})	$VD3 = 5\text{ V}$		100	125	mA

ABSOLUTE MAXIMUM RATINGS

Table 2

Parameter	Rating
RF Input Power	5 dBm
IFx Input Power (LO = 10 dBm, RF = -10 dBm)	15.5 dBm
LO Input Power	20 dBm
VD1, VD2	4.0 V
VD3	5.5 V
IFx Source or Sink Current	5 mA
Maximum Junction Temperature (T _J)	175°C
Lifetime at Maximum T _J	>1 × 10 ⁶ hours
Continuous Power Dissipation, P _{DISS} ¹ (T _A = 85°C, Derate 9.56 mW/°C Above 85°C)	0.65 W
Operating Temperature Range	-40°C to +85°C
Storage Temperature Range	-65°C to +150°C
Lead Temperature (Soldering 60 sec)	260°C
Moisture Sensitivity Level (MSL) ²	MSL3
Electrostatic Discharge (ESD) Sensitivity	
Human Body Model (HBM)	250V
Field Induced Charged Device Model (FICDM)	1250V

¹ P_{DISS} is a theoretical number calculated by (T_J - 85°C)/θ_{JC}.

² Based on IPC/JEDEC J-STD-20 MSL classifications.

Stresses at or above those listed under Absolute Maximum Ratings may cause permanent damage to the product. This is a stress rating only; functional operation of the product at these or any other conditions above those indicated in the operational section of this specification is not implied. Operation beyond the maximum operating conditions for extended periods may affect product reliability.

SOLDER PROFILE

The typical Pb-free reflow solder profile shown in Figure 2 is based on JEDEC J-STD-20C.

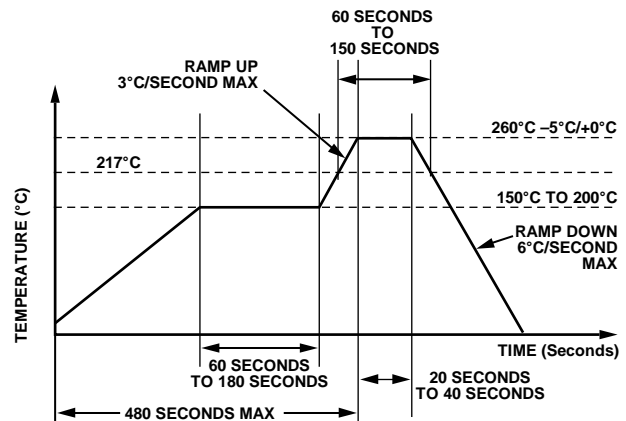

Figure 2. Pb-free Reflow Solder Profile

THERMAL RESISTANCE

Thermal performance is directly linked to PCB design and operating environment. Careful attention to PCB thermal design is required.

θ_{JA} is the natural convection junction to ambient thermal resistance measured in a one-cubic foot sealed enclosure. θ_{JC} is the junction to case thermal resistance.

Table 3. Thermal Resistance

Package Type ¹	θ _{JA}	θ _{JC}	Unit
E-32-1	46	71	°C/W

¹ Test Condition 1: JEDEC standard JESD51-2.

ESD CAUTION



ESD (electrostatic discharge) sensitive device. Charged devices and circuit boards can discharge without detection. Although this product features patented or proprietary protection circuitry, damage may occur on devices subjected to high energy ESD. Therefore, proper ESD precautions should be taken to avoid performance degradation or loss of functionality.

PIN CONFIGURATION AND FUNCTION DESCRIPTIONS

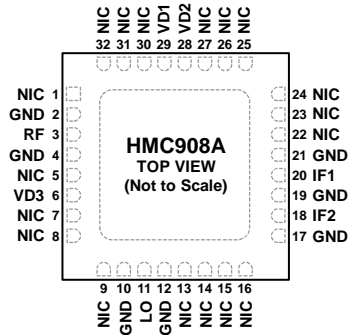

- NOTES**
1. NIC = NO INTERNAL CONNECTION. THESE PINS ARE NOT CONNECTED INTERNALLY.
 2. EXPOSED PAD. THE EXPOSED PAD MUST BE CONNECTED TO THE RF AND DC GROUND.

Figure 3. Pin Configuration

Table 4. Pin Function Descriptions

Pin No.	Mnemonic	Description
1, 5, 7 to 9, 13 to 16, 22 to 27, 30 to 32	NIC	No Internal Connection. These pins are not connected internally.
2, 4, 10, 12, 17, 19, 21	GND	Ground Connect. These pins and package bottom must be connected to RF and dc ground.
3	RF	Radio Frequency Port. This pin is ac-coupled and matched to 50 Ω.
6	VD3	Power Supply for LO Amplifier.
11	LO	Local Oscillator Port. The pin is ac-coupled and matched to 50 Ω.
18	IF2	Second Quadrature Intermediate Frequency Output Pin. For applications not requiring operation to dc, use an off chip dc blocking capacitor. For operation to dc, these pins must not source or sink more than 5 mA of current.
20	IF1	First Quadrature Intermediate Frequency Output Pin. For applications not requiring operation to dc, use an off chip dc blocking capacitor. For operation to dc, these pins must not source or sink more than 5 mA of current.
28, 29	VD2, VD1 EPAD	Power Supply for RF Low Noise Amplifier. Exposed Pad. The exposed pad must be connected to the RF and dc ground.

INTERFACE SCHEMATICS



Figure 4. GND Interface Schematic

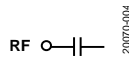

Figure 5. RF Interface Schematic

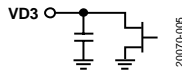

Figure 6. VD3 Interface Schematic

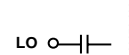

Figure 7. LO Interface Schematic

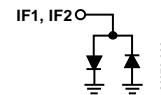

Figure 8. IF1, IF2 Interface Schematic

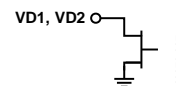

Figure 9. VD1, VD2 Interface Schematic

TYPICAL PERFORMANCE CHARACTERISTICS

DOWNCONVERTER PERFORMANCE: $IF_{OUT} = 100$ MHz, UPPER SIDEBAND (LOW-SIDE LO)

Data taken as an image rejection mixer with external 90° hybrid at the IF ports, LO = 0 dBm, unless otherwise noted.

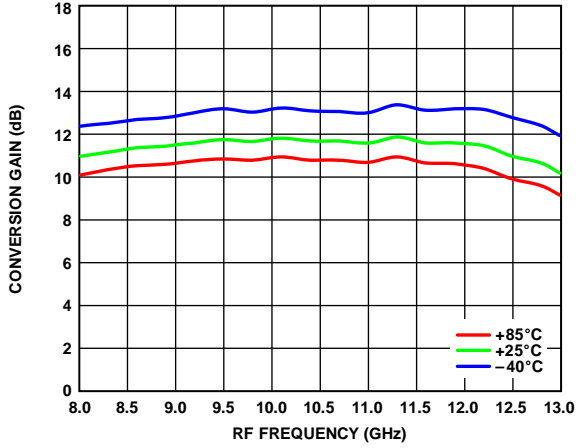

Figure 10. Conversion Gain vs. RF Frequency at Various Temperatures

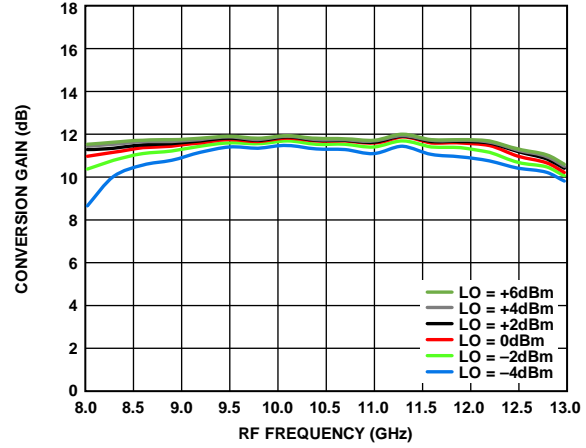

Figure 13. Conversion Gain vs. RF Frequency at Various LO Powers, $T_A = 25^\circ\text{C}$

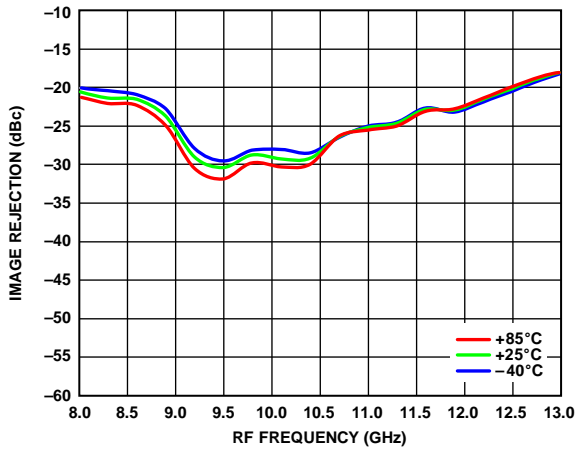

Figure 11. Image Rejection vs. RF Frequency at Various Temperatures

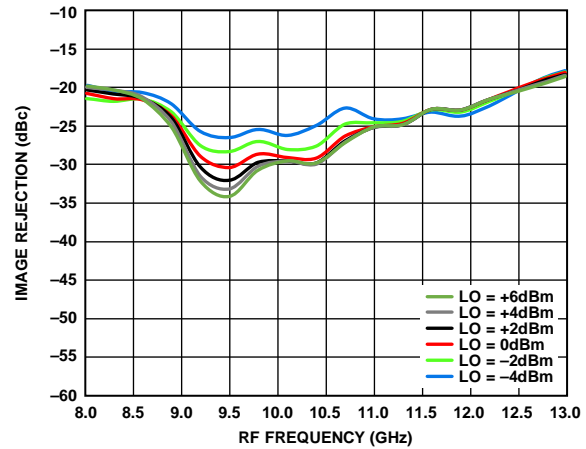

Figure 14. Image Rejection vs. RF Frequency at Various LO Powers, $T_A = 25^\circ\text{C}$

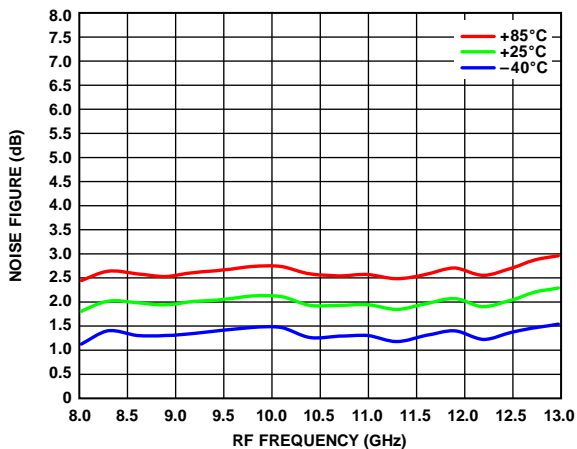

Figure 12. Noise Figure vs. RF Frequency at Various Temperatures

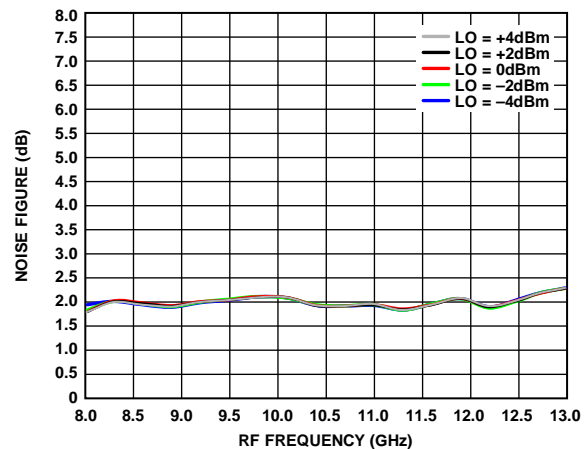

Figure 15. Noise Figure vs. RF Frequency at Various LO Powers, $T_A = 25^\circ\text{C}$

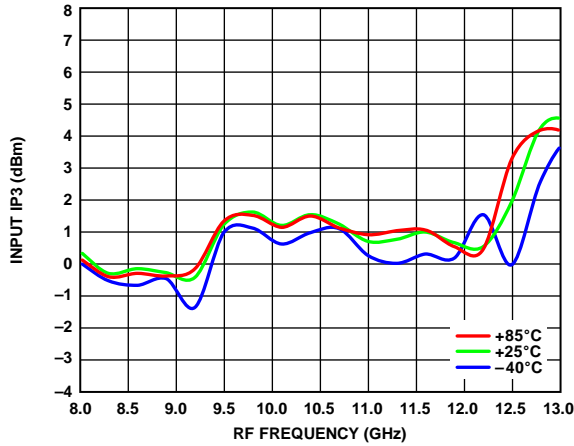

Figure 16. Input IP3 vs. RF Frequency at Various Temperatures

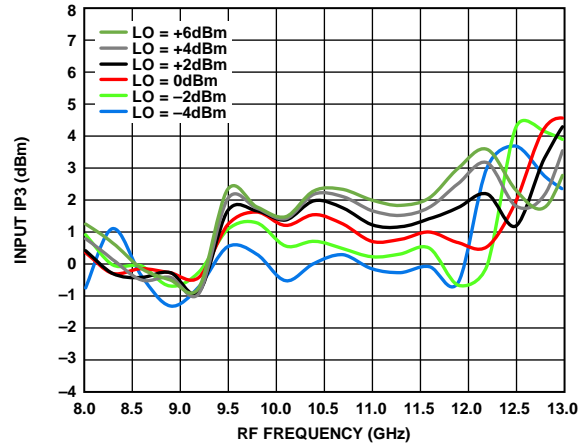

Figure 19. Input IP3 vs. RF Frequency at Various LO Powers, $T_A = 25^\circ\text{C}$

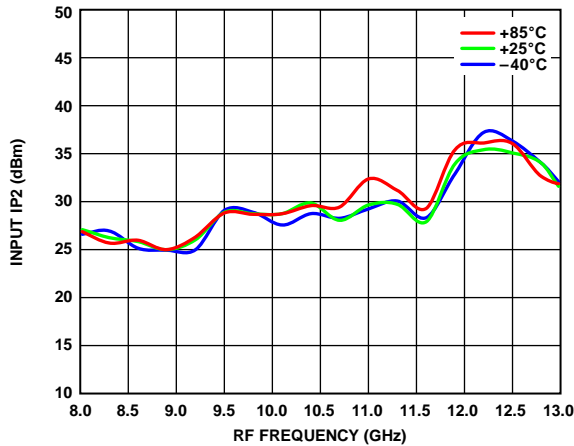

Figure 17. Input IP2 vs. RF Frequency at Various Temperatures

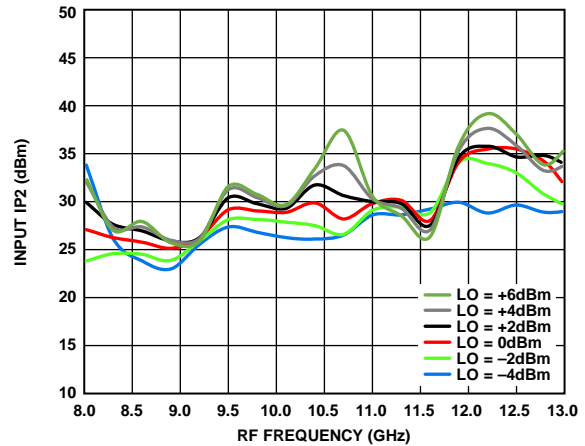

Figure 20. Input IP2 vs. RF Frequency at Various LO Powers, $T_A = 25^\circ\text{C}$

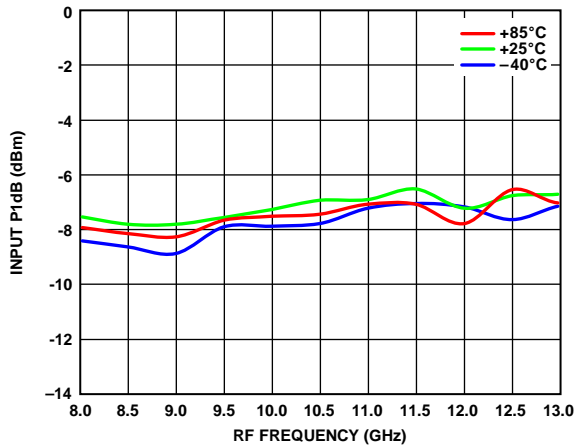

Figure 18. Input P1dB vs. RF Frequency at Various Temperatures

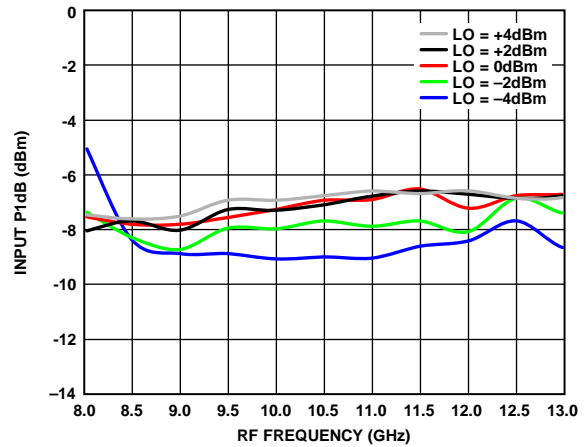

Figure 21. Input P1dB vs. RF Frequency at Various LO Powers, $T_A = 25^\circ\text{C}$

20070-015

20070-018

20070-016

20070-019

20070-017

20070-020

DOWNCONVERTER PERFORMANCE: IF_{OUT} = 100 MHz, LOWER SIDEBAND (HIGH-SIDE LO)

Data taken as an image rejection mixer with external 90° hybrid at the IF ports, LO = 0 dBm, unless otherwise noted.

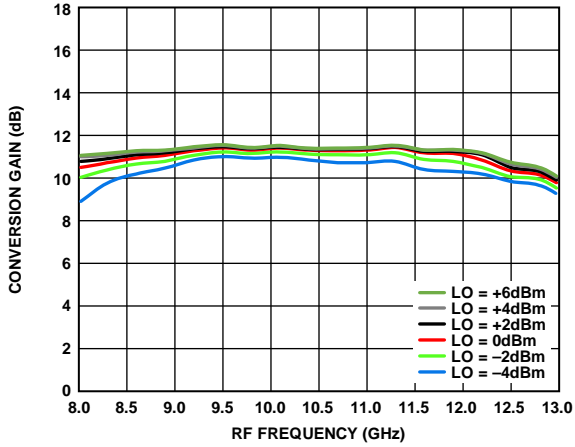

Figure 22. Conversion Gain vs. RF Frequency at Various LO Powers, T_A = 25°C

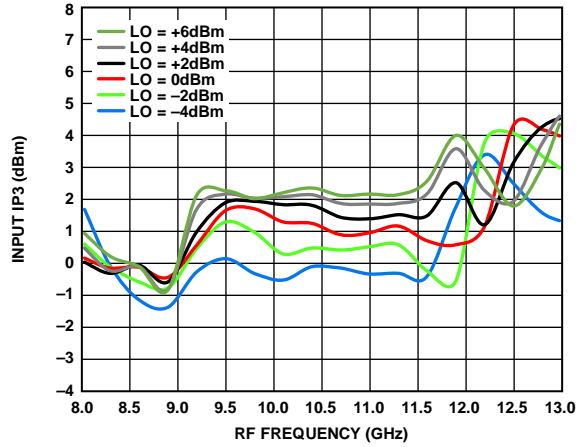

Figure 25. Input IP3 vs. RF Frequency at Various LO Powers, T_A = 25°C

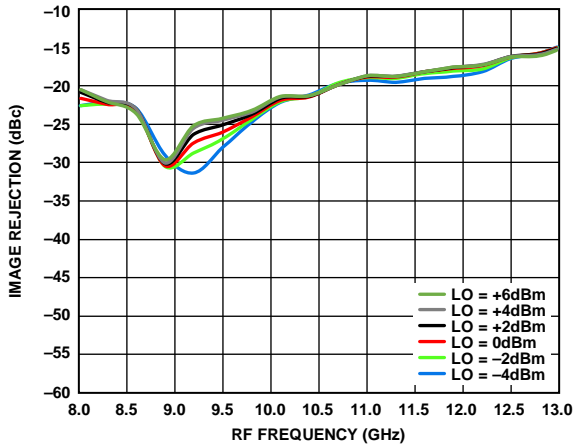

Figure 23. Image Rejection vs. RF Frequency at Various LO Powers, T_A = 25°C

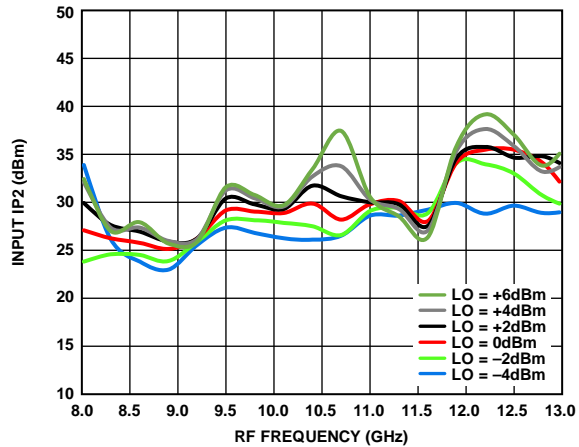

Figure 26. Input IP2 vs. RF Frequency at Various LO Powers, T_A = 25°C

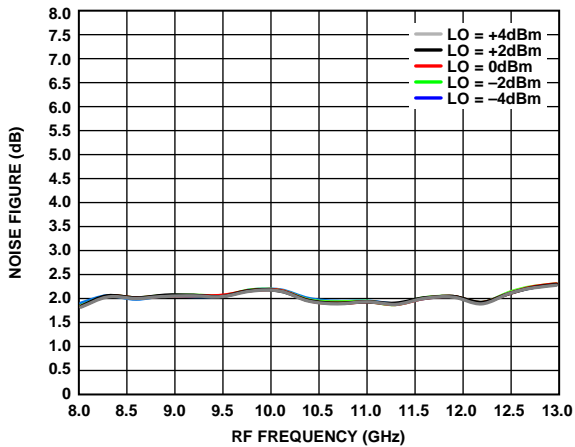

Figure 24. Noise Figure vs. RF Frequency at Various LO Powers, T_A = 25°C

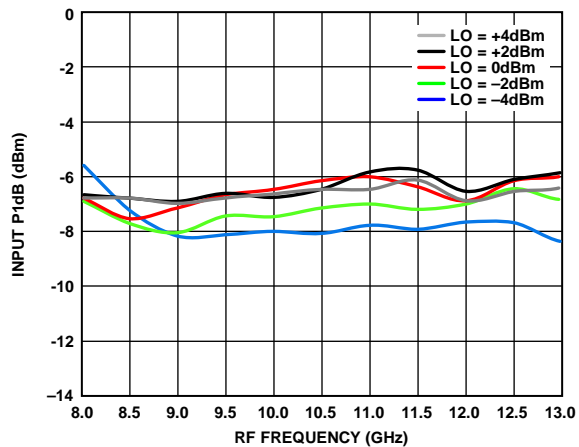

Figure 27. Input P1dB vs. RF Frequency at Various LO Powers, T_A = 25°C

DOWNCONVERTER PERFORMANCE: IF_{OUT} = 3500 MHz, UPPER SIDEBAND (LOW-SIDE LO)

Data taken as an image rejection mixer with external 90° hybrid at the IF ports, LO = 0 dBm, unless otherwise noted.

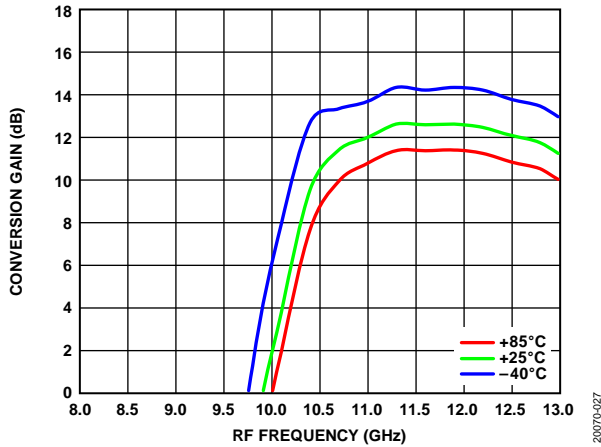

Figure 28. Conversion Gain vs. RF Frequency at Various Temperatures

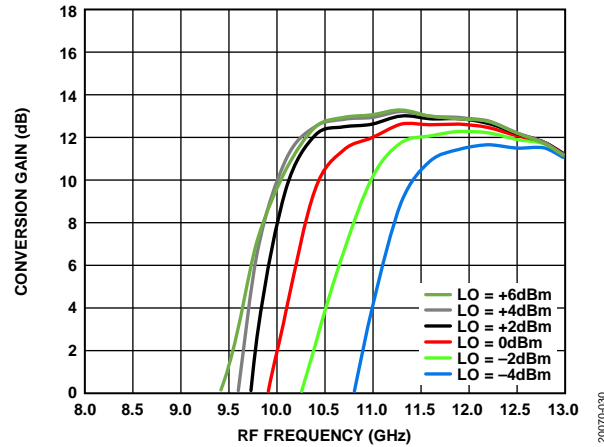

Figure 31. Conversion Gain vs. RF Frequency at Various LO Powers, T_A = 25°C

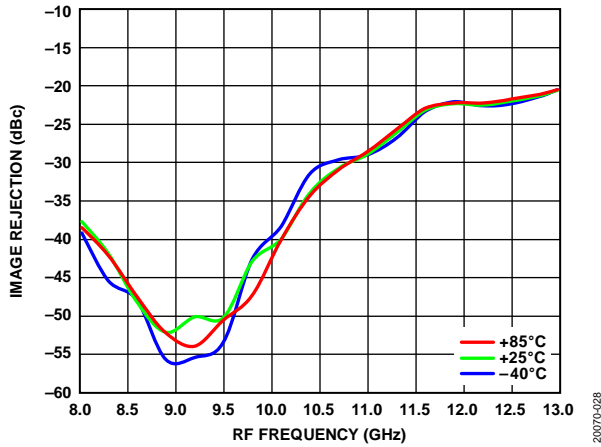

Figure 29. Image Rejection vs. RF Frequency at Various Temperatures

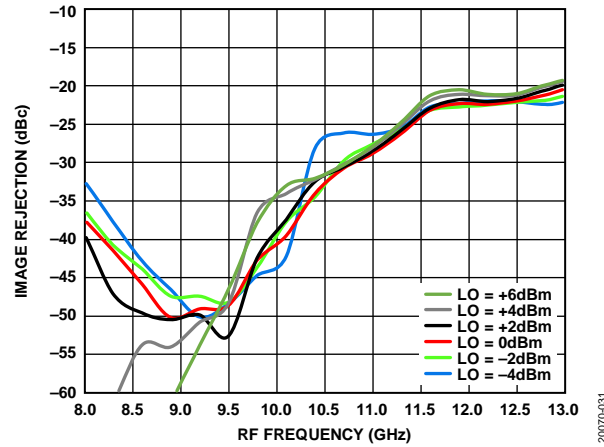

Figure 32. Image Rejection vs. RF Frequency at Various LO Powers, T_A = 25°C

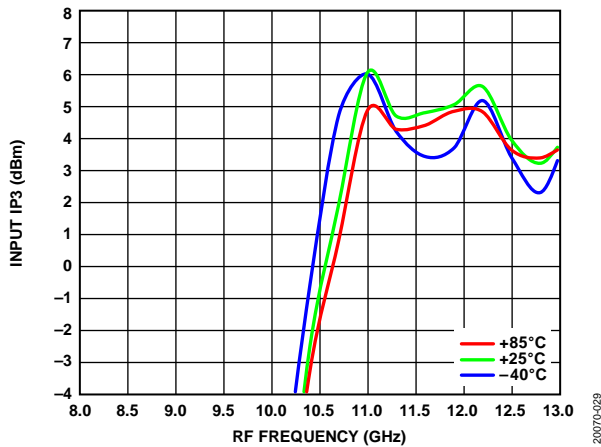

Figure 30. Input IP3 vs. RF Frequency at Various Temperatures

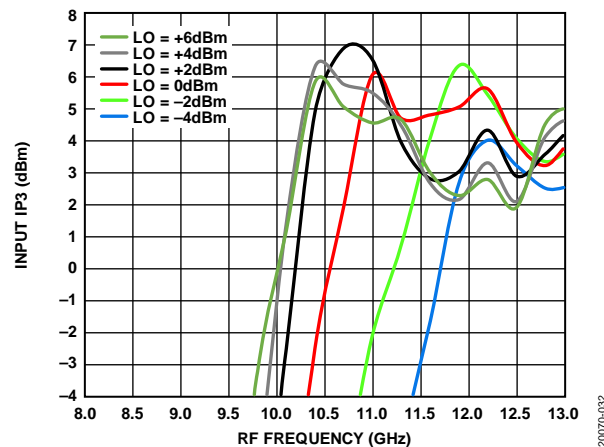

Figure 33. Input IP3 vs. RF Frequency at Various LO Powers, T_A = 25°C

20070-027

20070-030

20070-028

20070-031

20070-029

20070-032

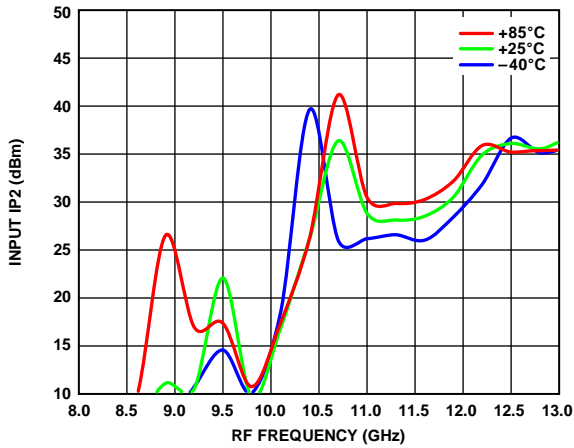

Figure 34. Input IP2 vs. RF Frequency at Various Temperatures

20070-033

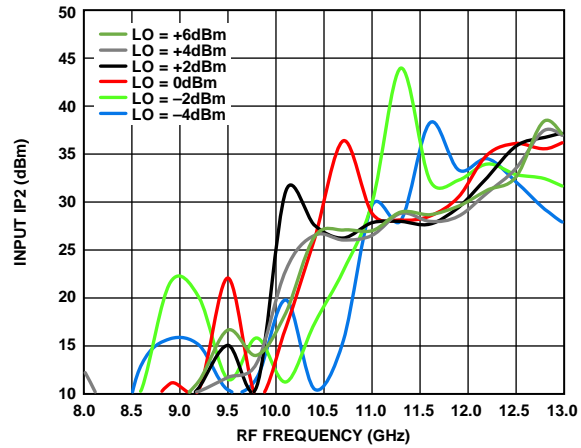

Figure 37. Input IP2 vs. RF Frequency at Various LO Powers, $T_A = 25^\circ\text{C}$

20070-036

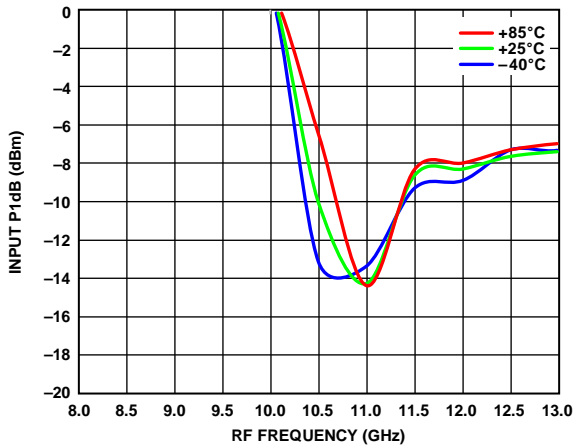

Figure 35. Input P1dB vs. RF Frequency at Various Temperatures

20070-034

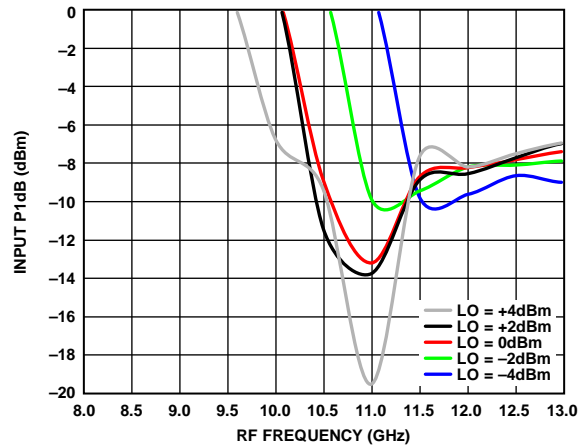

Figure 38. Input P1dB vs. RF Frequency at Various LO Powers, $T_A = 25^\circ\text{C}$

20070-037

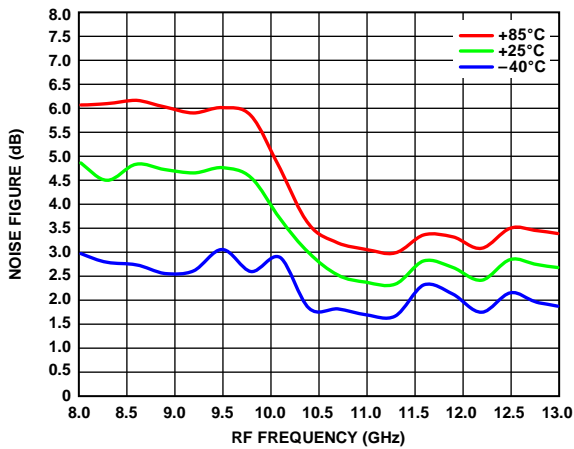

Figure 36. Noise Figure vs. RF Frequency at Various Temperatures

20070-035

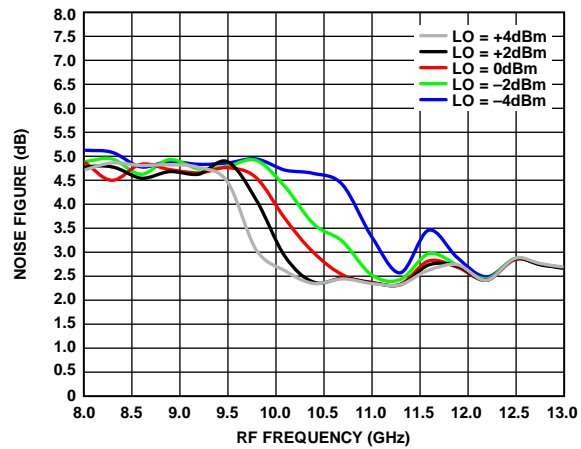

Figure 39. Noise Figure vs. RF Frequency at Various LO Powers, $T_A = 25^\circ\text{C}$

20070-038

DOWNCONVERTER PERFORMANCE: IF_{OUT} = 3500 MHz, LOWER SIDEBAND (HIGH-SIDE LO)

Data taken as an image rejection mixer with external 90° hybrid at the IF ports, LO = 0 dBm, unless otherwise noted.

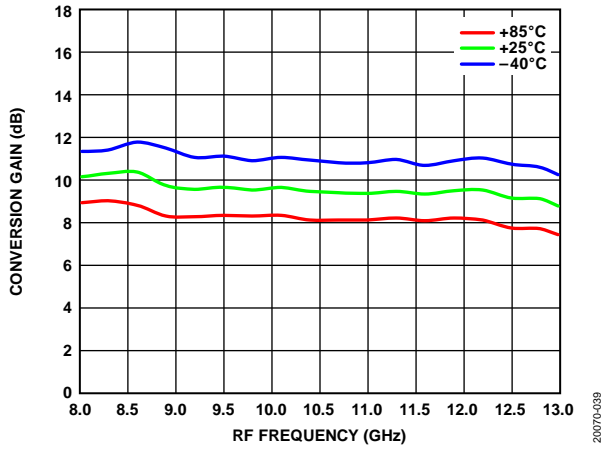

Figure 40. Conversion Gain vs. RF Frequency at Various Temperatures

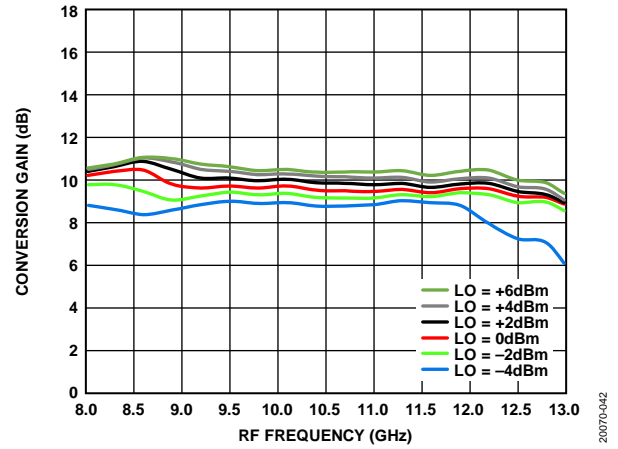

Figure 43. Conversion Gain vs. RF Frequency at Various LO Powers, $T_A = 25^\circ\text{C}$

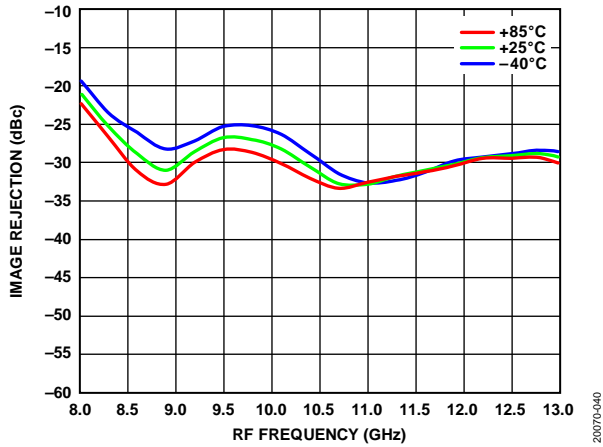

Figure 41. Image Rejection vs. RF Frequency at Various Temperatures

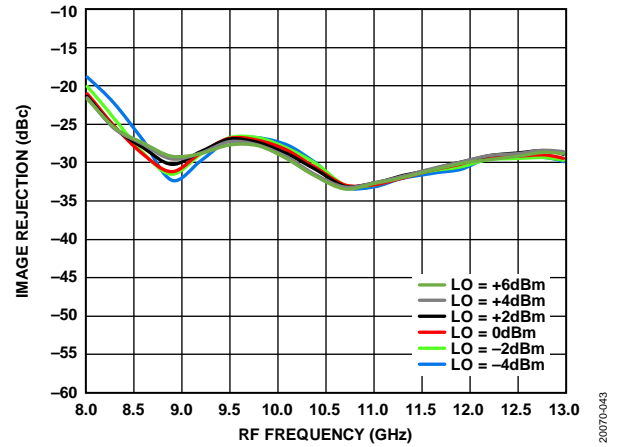

Figure 44. Image Rejection vs. RF Frequency at Various LO Powers, $T_A = 25^\circ\text{C}$

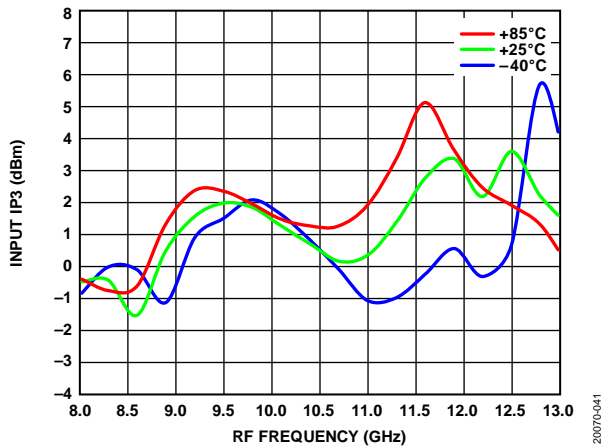

Figure 42. Input IP3 vs. RF Frequency at Various Temperatures

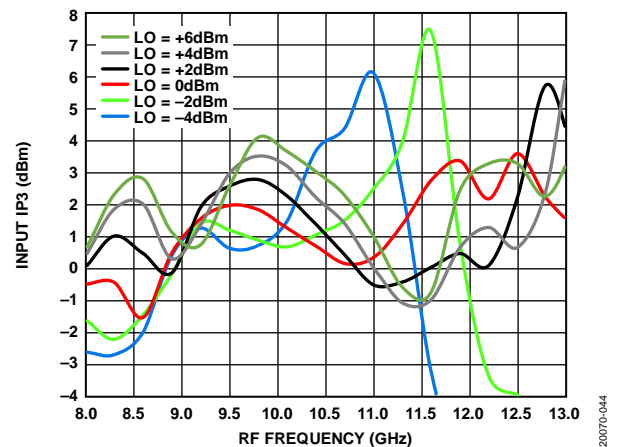

Figure 45. Input IP3 vs. RF Frequency at Various LO Powers, $T_A = 25^\circ\text{C}$

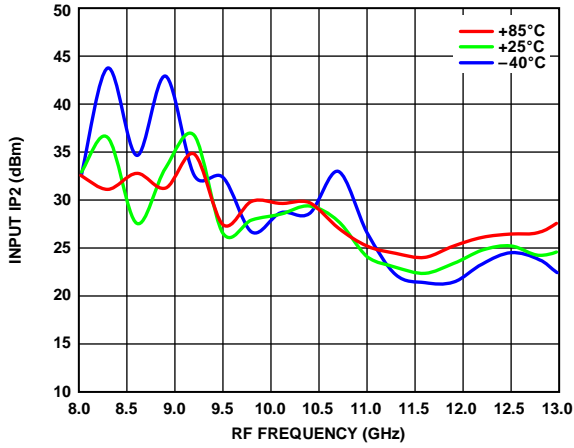

Figure 46. Input IP2 vs. RF Frequency at Various Temperatures

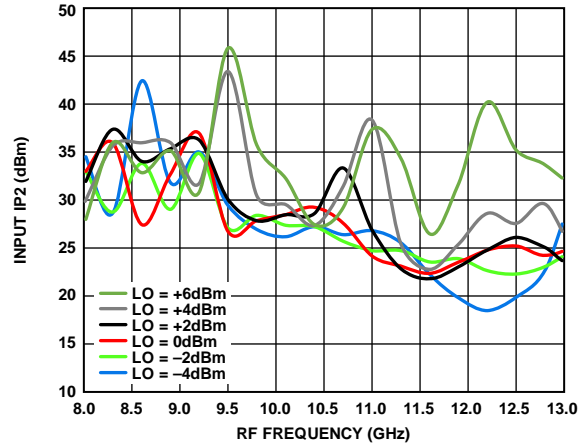

Figure 49. Input IP2 vs. RF Frequency at Various LO Powers, $T_A = 25^\circ\text{C}$

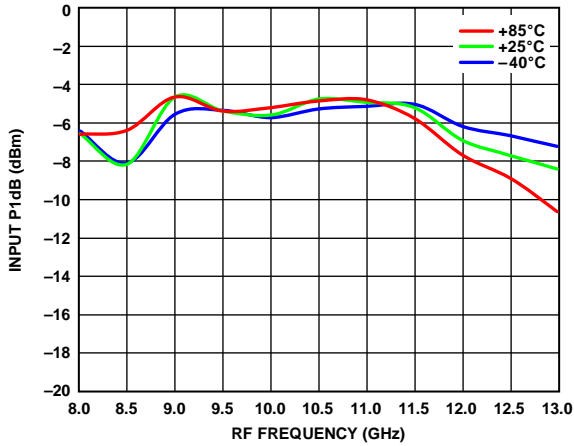

Figure 47. Input P1dB vs. RF Frequency at Various Temperatures

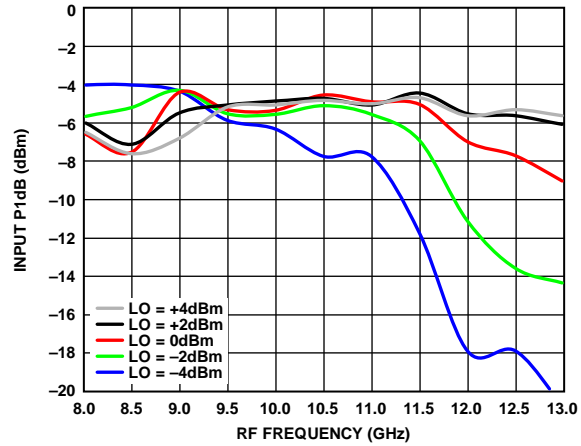

Figure 50. Input P1dB vs. RF Frequency at Various LO Powers, $T_A = 25^\circ\text{C}$

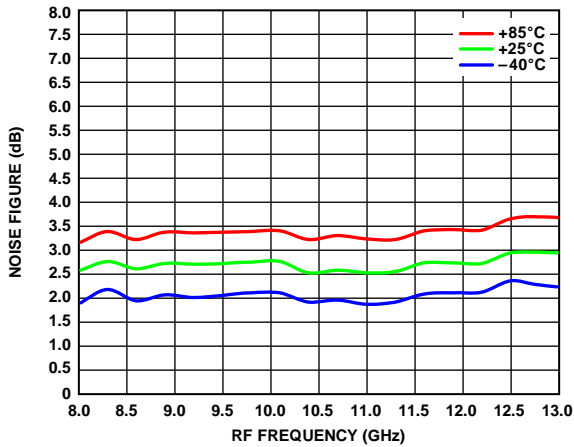

Figure 48. Noise Figure vs. RF Frequency at Various Temperatures

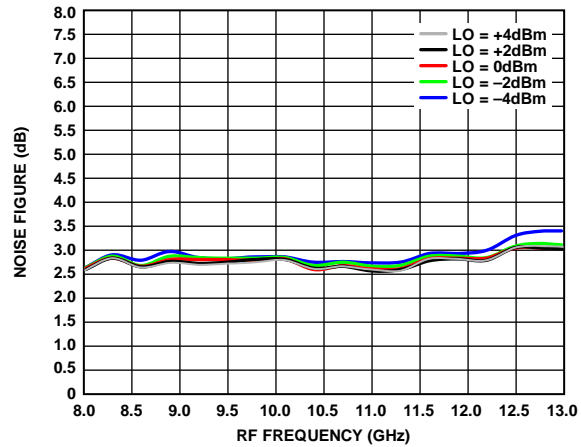

Figure 51. Noise Figure vs. RF Frequency at Various LO Powers, $T_A = 25^\circ\text{C}$

DOWNCONVERTER PERFORMANCE: IF BANDWIDTH, UPPER SIDEBAND (LOW-SIDE LO)

Data taken as an image rejection mixer with external 90° hybrid at the IF ports, LO = 0 dBm at 8.5 GHz, unless otherwise noted.

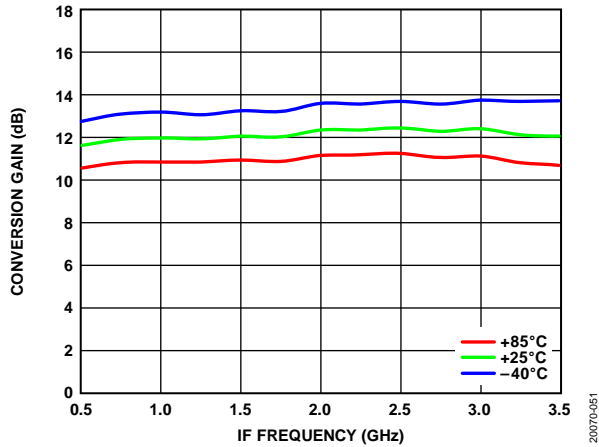

Figure 52. Conversion Gain vs. IF Frequency at Various Temperatures

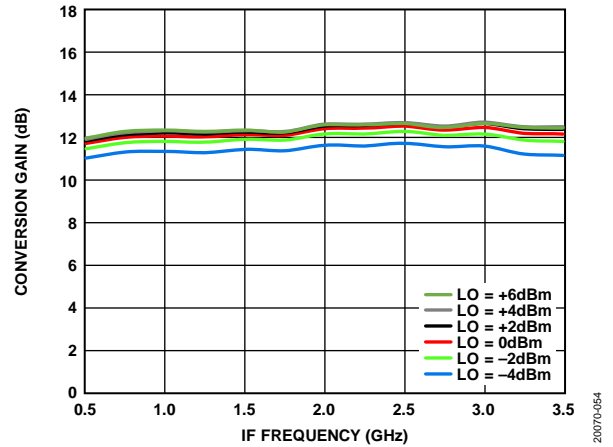

Figure 55. Conversion Gain vs. IF Frequency at Various LO Powers, $T_A = 25^\circ\text{C}$

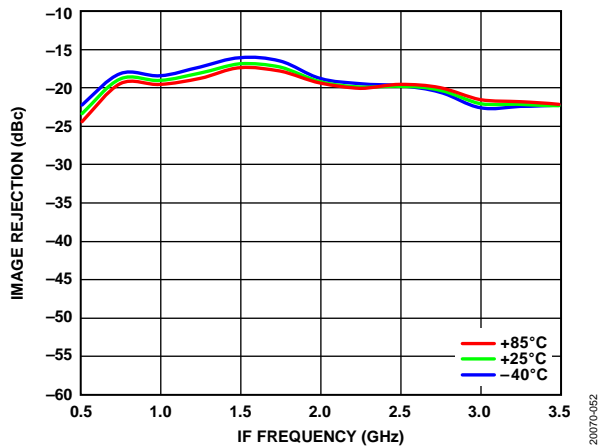

Figure 53. Image Rejection vs. IF Frequency at Various Temperatures

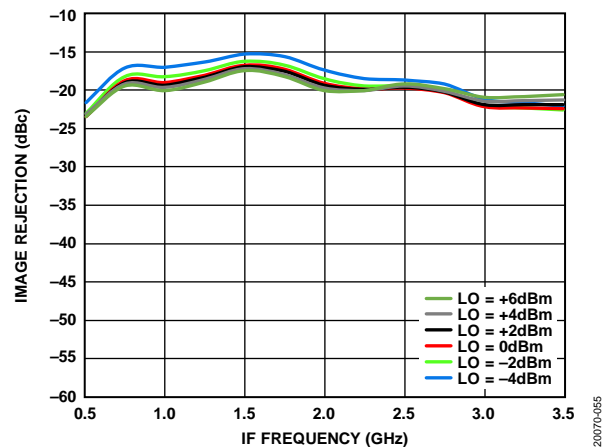

Figure 56. Image Rejection vs. IF Frequency at Various LO Powers, $T_A = 25^\circ\text{C}$

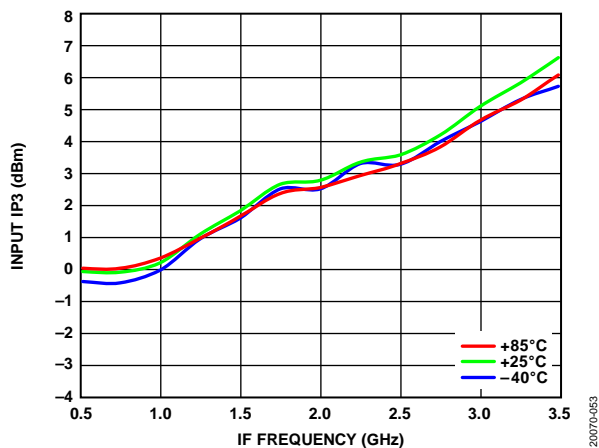

Figure 54. Input IP3 vs. IF Frequency at Various Temperatures

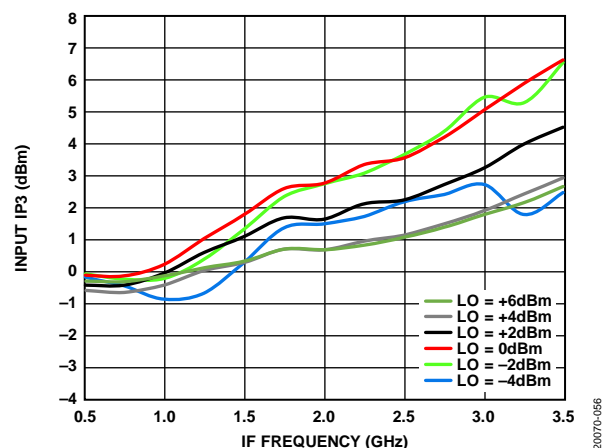

Figure 57. Input IP3 vs. IF Frequency at Various LO Powers, $T_A = 25^\circ\text{C}$

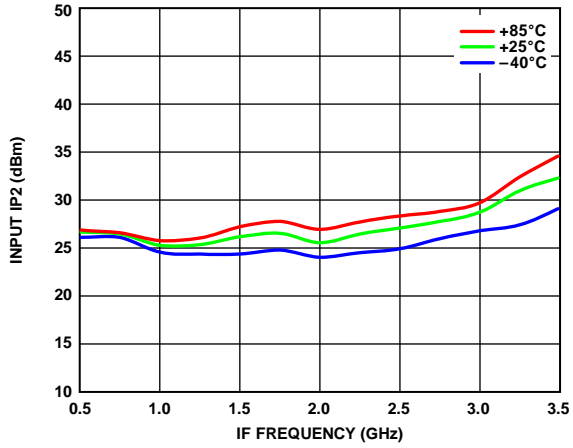

Figure 58. Input IP2 vs. IF Frequency at Various Temperatures

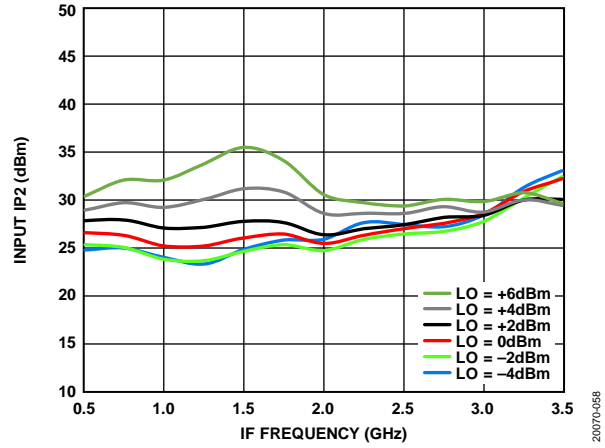

Figure 59. Input IP2 vs. IF Frequency at Various LO Powers, $T_A = 25^\circ\text{C}$

Noise Figure, IF Bandwidth, Upper Sideband at LO = 10 GHz

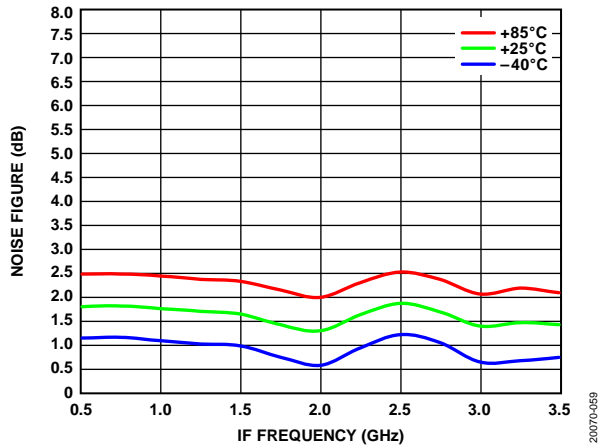

Figure 60. Noise Figure vs. IF Frequency at Various Temperatures

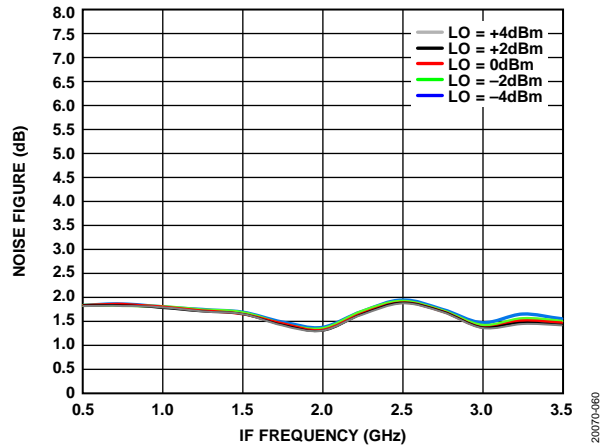

Figure 61. Noise Figure vs. IF Frequency at Various LO Powers, $T_A = 25^\circ\text{C}$

DOWNCONVERTER PERFORMANCE: IF BANDWIDTH, LOWER SIDE BAND (HIGH-SIDE LO)

Data taken as an image rejection mixer with external 90° hybrid at the IF ports, LO = 0 dBm at 12.5 GHz, unless otherwise noted.

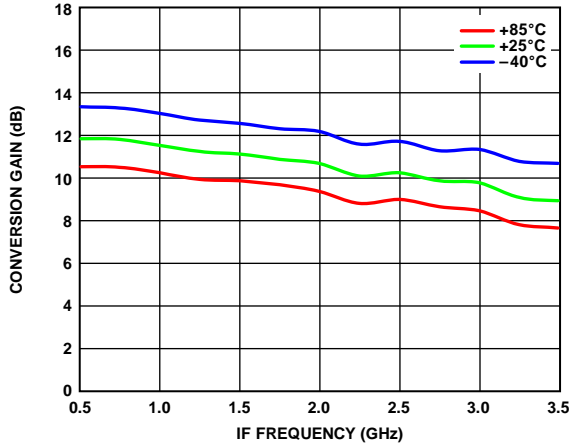

Figure 62. Conversion Gain vs. IF Frequency at Various Temperatures

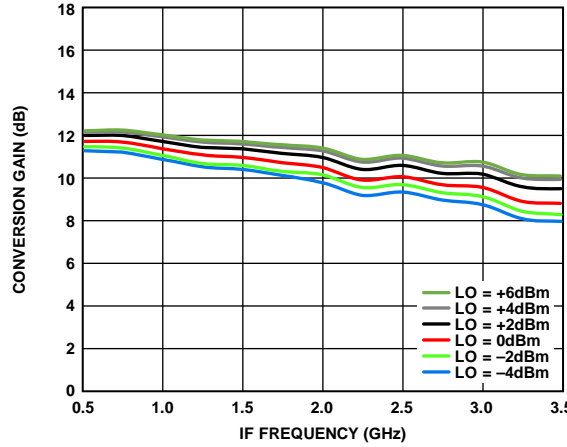

Figure 65. Conversion Gain vs. IF Frequency at Various LO Powers, $T_A = 25^\circ\text{C}$

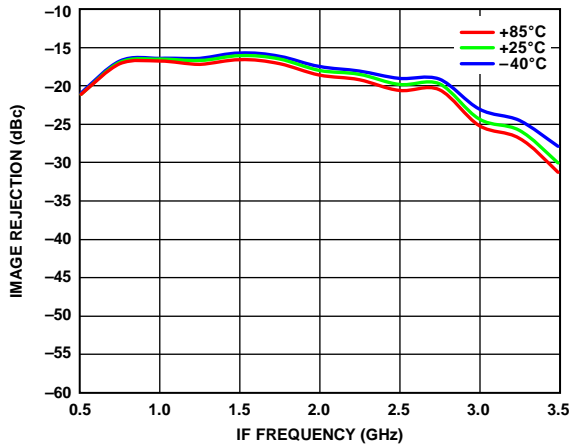

Figure 63. Image Rejection vs. IF Frequency at Various Temperatures

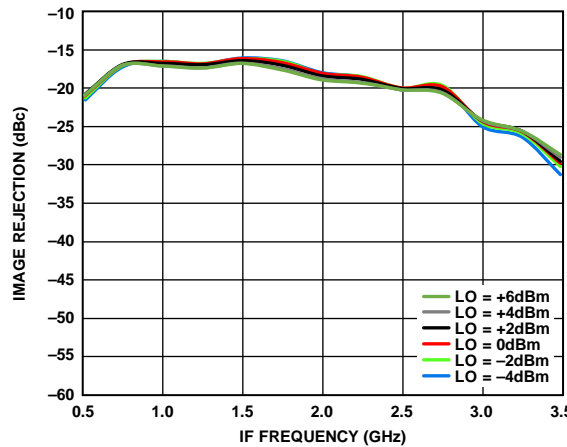

Figure 66. Image Rejection vs. IF Frequency at Various LO Powers, $T_A = 25^\circ\text{C}$

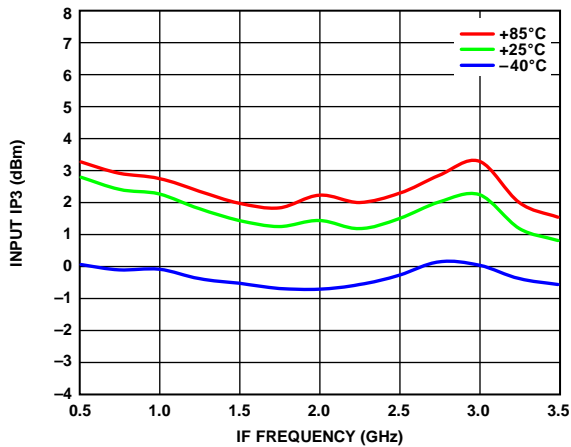

Figure 64. Input IP3 vs. IF Frequency at Various Temperatures

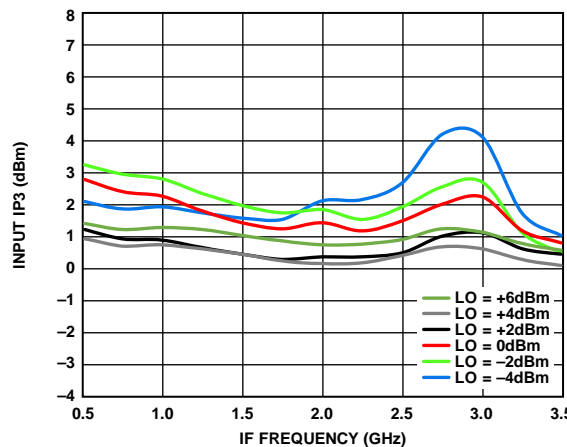

Figure 67. Input IP3 vs. IF Frequency at Various LO Powers, $T_A = 25^\circ\text{C}$

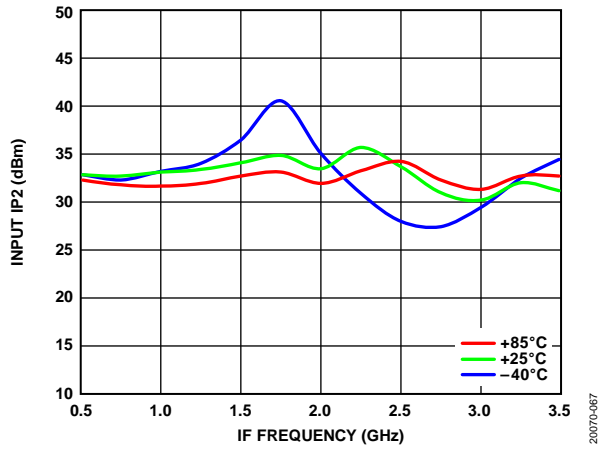

Figure 68. Input IP2 vs. IF Frequency at Various Temperatures

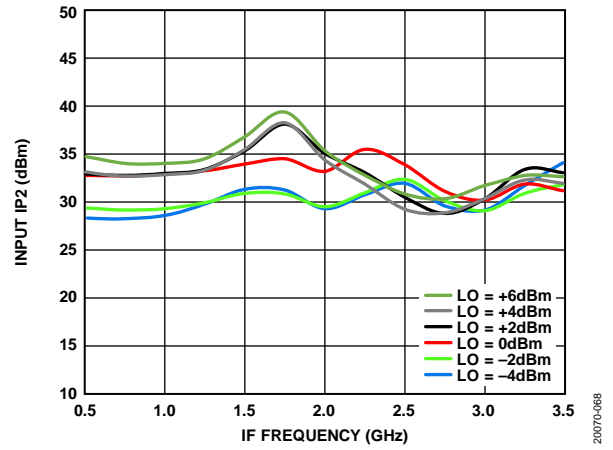

Figure 69. Input IP2 vs. IF Frequency at Various LO Powers, $T_A = 25^\circ\text{C}$

Noise Figure, IF Bandwidth, Lower Sideband at LO = 10 GHz

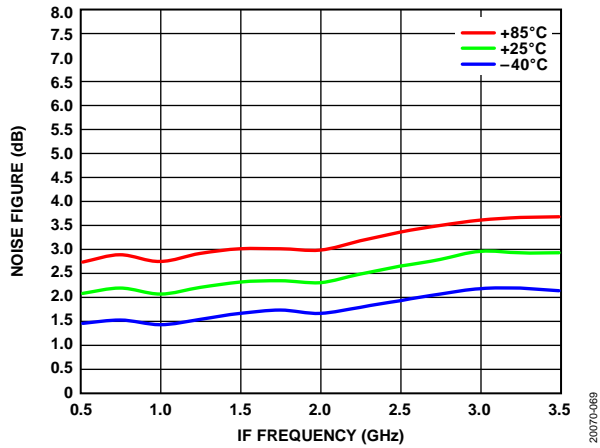

Figure 70. Noise Figure vs. IF Frequency at Various Temperatures

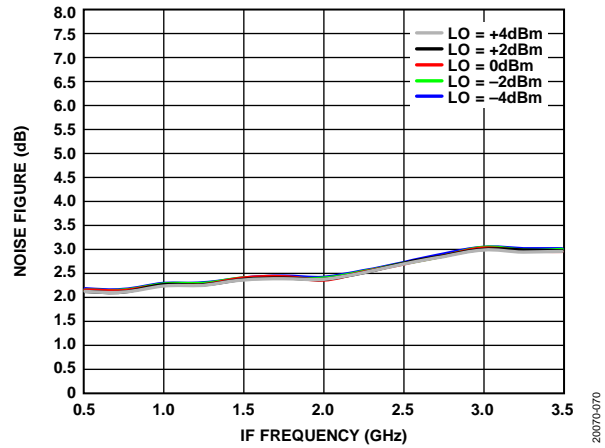

Figure 71. Noise Figure vs. IF Frequency at Various LO Powers, $T_A = 25^\circ\text{C}$

AMPLITUDE/PHASE BALANCE, DOWNCONVERTER

Data taken at various LO powers.

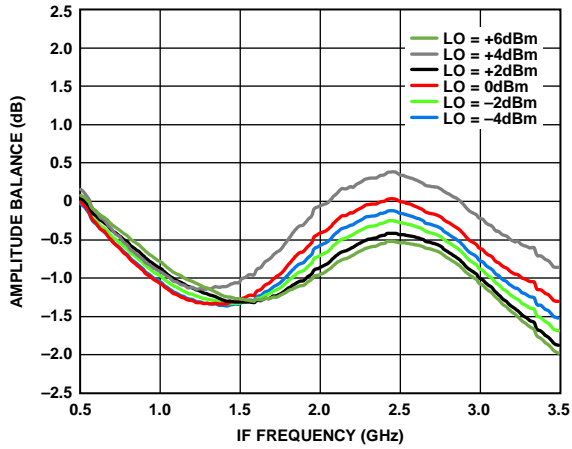

Figure 72. Amplitude Balance vs. IF Frequency at Various LO powers, Upper Sideband, $T_A = 25^\circ\text{C}$

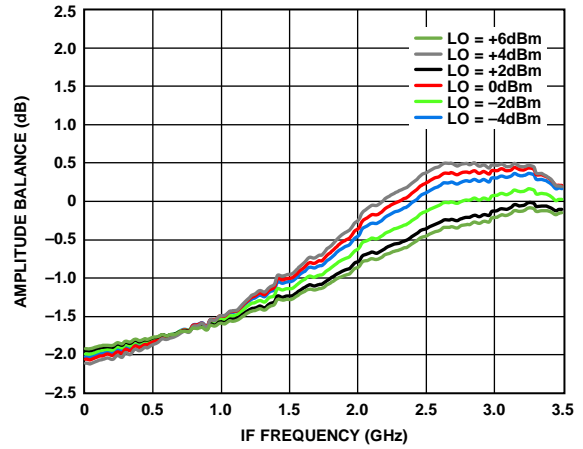

Figure 74. Amplitude Balance vs. IF Frequency at Various LO powers, Lower Sideband, $T_A = 25^\circ\text{C}$

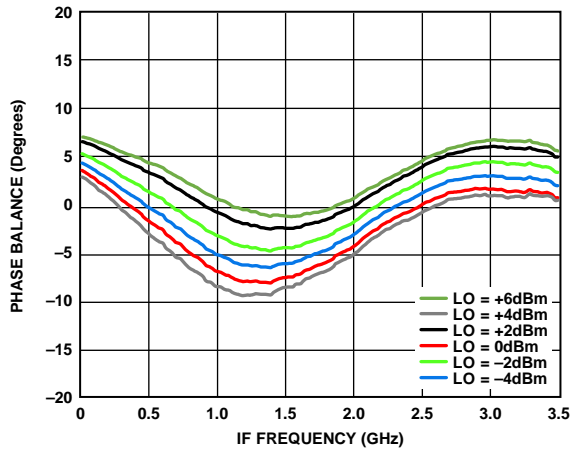

Figure 73. Phase Balance vs. IF Frequency at Various LO Powers, Upper Sideband, $T_A = 25^\circ\text{C}$

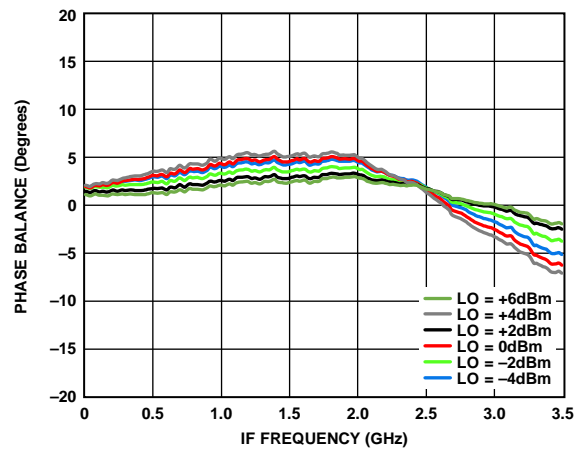

Figure 75. Phase Balance vs. IF Frequency at Various LO Powers, Lower Sideband, $T_A = 25^\circ\text{C}$

ISOLATION AND RETURN LOSS

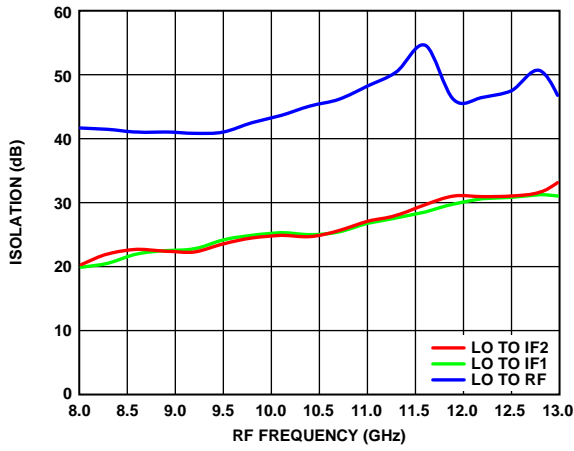

Figure 76. Isolation vs. RF Frequency at LO = 0 dBm, $T_A = 25^\circ\text{C}$

20070-075

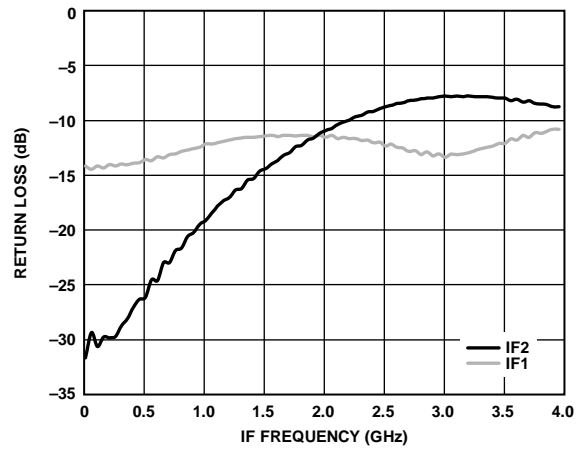

Figure 78. Return Loss vs. IF Frequency, LO = 17 dBm, $T_A = 25^\circ\text{C}$

20070-077

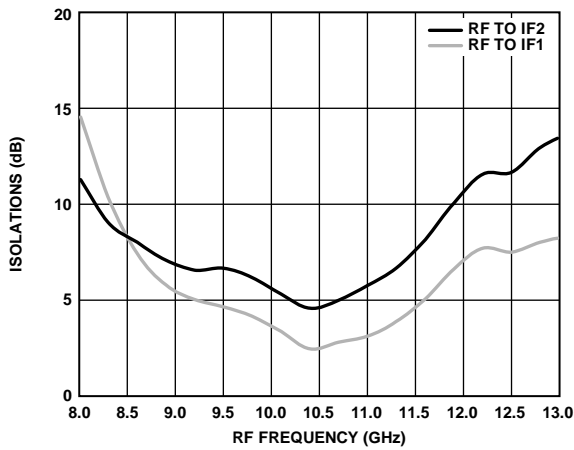

Figure 77. Isolation vs. RF Frequency at LO = 0 dBm, $T_A = 25^\circ\text{C}$

20070-076

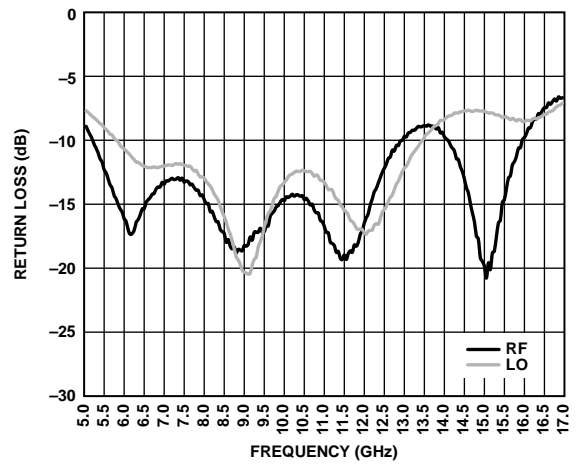

Figure 79. Return Loss vs. Frequency, LO = 0 dBm at 10 GHz, $T_A = 25^\circ\text{C}$

20070-078

SPURIOUS OUTPUT PERFORMANCE

LO Harmonics

When measuring the LO harmonics, the 0 dBm LO input power is applied at various LO frequencies.

All values are in decibels below the LO power level measured at the RF port. N/A means not applicable.

Table 5. LO Harmonics at RF

LO Frequency (MHz)	N x LO Spur at RF Port (dBc)			
	1	2	3	4
8500	43	50	52	68
9000	43	46	57	65
9500	44	52	57	78
10,000	45	57	60	66
10,500	47	78	58	66
11,000	51	80	59	67
11,500	57	61	52	68
12,000	49	64	49	78
12,500	49	72	56	86

Downconverter, M x N, Upper Sideband

RF = 10.6 GHz, LO = 10.5 GHz, RF power = -20 dBm, and LO power = 0 dBm, data taken without external hybrid. Mixer spurious products are measured in dBc from the IF output power level. (M x RF) - (N x LO) values are positive. N/A means not applicable.

		N x LO				
		0	1	2	3	4
M x RF	0	N/A	14	38	48	N/A
	1	14	0	38	45	71
	2	66	57	55	57	84
	3	78	84	73	56	69
	4	N/A	83	83	89	95

Downconverter, M x N, Lower Sideband

RF = 10.4 GHz, LO = 10.5 GHz, RF power = -20 dBm, and LO power = 0 dBm, data taken without external hybrid. Mixer spurious products are measured in dBc from the IF output power level. (M x RF) - (N x LO) values are positive. N/A means not applicable.

		N x LO				
		0	1	2	3	4
M x RF	0	N/A	15	39	45	N/A
	1	12	0	41	47	70
	2	69	55	53	57	85
	3	75	83	72	51	69
	4	N/A	82	82	89	89

THEORY OF OPERATION

The HMC908A is a compact, GaAs, MMIC, I/Q downconverter in a RoHS compliant package optimized for point to point and point to multipoint microwave radio applications operating in the 9 GHz to 12 GHz input RF frequency range. The HMC908A supports LO input frequencies of 8.5 GHz to 15.5 GHz and IF output frequencies of dc to 3.5 GHz.

The HMC908A uses an RF LNA amplifier followed by an I/Q double balanced mixer, where a driver amplifier drives the LO (see Figure 1).

LO DRIVER AMPLIFIER

The LO driver amplifier takes a single LO input and amplifies it to the desired LO signal level for the mixer to operate optimally. The LO driver amplifier is self biased, and it only requires a single dc bias voltage (VD3) to operate. The bias current for the LO amplifier is 100 mA at 5 V, typically. The LO drive level of -4 dBm to +6 dBm makes it compatible with the Analog Devices, Inc., wideband synthesizer portfolio without the need for an external LO driver amplifier.

MIXER

The mixer is an I/Q double balanced mixer, and this mixer topology reduces the need for filtering the unwanted sideband. An external 90° hybrid is required to select the desired sideband of operation.

LNA

The LNA (RF amplifier) is self biased. The bias current for the LNA is 53 mA at 3 V, typically.

The typical application circuit (see Figure 81) shows the necessary external components on the bias lines to eliminate any undesired stability problems for the RF amplifier and the LO amplifier.

The HMC908A is a much smaller alternative to hybrid style image rejection converter assemblies, and it eliminates the need for wire bonding by allowing the use of surface-mount manufacturing assemblies.

The HMC908A downconverter comes in a compact, 4.9 mm × 4.9 mm, 32-terminal ceramic LCC. The HMC908A operates over the -40°C to +85°C temperature range.

APPLICATIONS INFORMATION

Figure 81 shows the typical application circuit for the HMC908A. To select the appropriate sideband, an external 90° hybrid coupler is needed. For applications not requiring operation to dc, using an off chip, dc blocking capacitor is recommended. For applications that require the LO signal at the output to be suppressed, use a bias tee or RF feed. Ensure that the source or sink current used for LO suppression is <5 mA for each IF port to prevent damage to the device. The common-mode voltage for each IF port is 0 V.

To select the upper sideband (low-side LO), connect the IF1 pin to the 0° port of the hybrid and connect the IF2 pin to the 90° port of the hybrid. To select the lower sideband (high-side LO), connect the IF1 pin to the 90° port of the hybrid and connect the IF2 pin to the 0° port of the hybrid. The output is from the sum port of the hybrid, and the difference port is 50 Ω terminated.

The EV1HMC908ALC5 evaluation PCB used in the application must use RF circuit design techniques. Signal lines must have 50 Ω impedance, and connect the package ground leads and exposed pad directly to the ground plane, similar to Figure 82. Use a sufficient number of via holes to connect the top and bottom ground planes. The evaluation circuit board shown in Figure 82 is available from Analog Devices upon request.

LAYOUT

Solder the exposed pad on the underside of the HMC908A to a low thermal and electrical impedance ground plane. This pad is typically soldered to an exposed opening in the solder mask on the evaluation board. Connect these ground vias to all other ground layers on the evaluation board to maximize heat dissipation from the device package. Figure 80 shows the PCB land pattern footprint for the EV1HMC908ALC5 evaluation board.

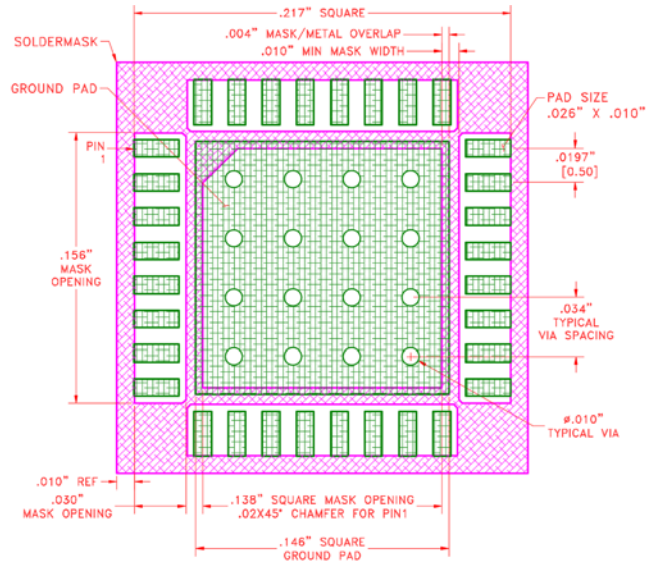

Figure 80. PCB Land Pattern Footprint of the EV1HMC908ALC5

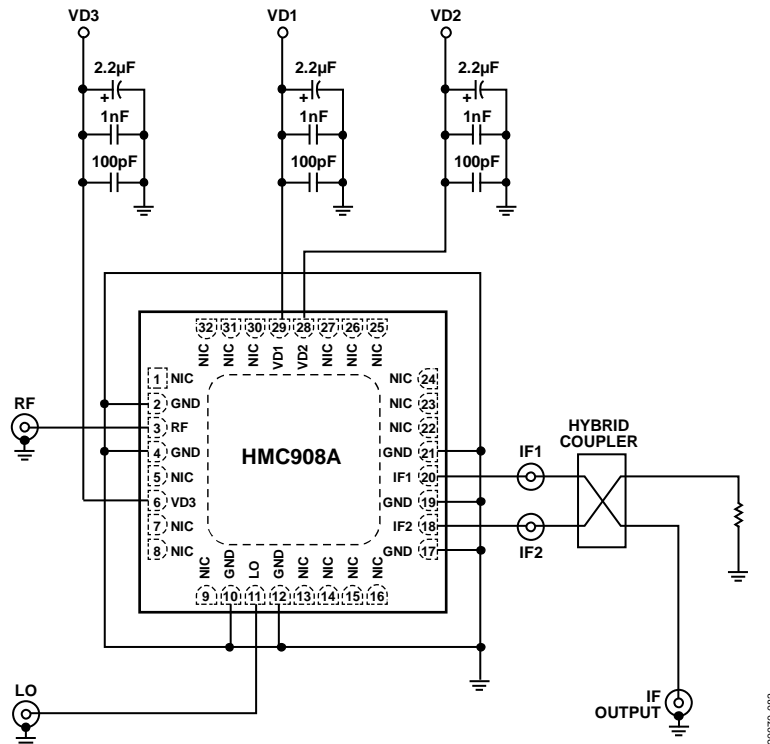

Figure 81. Typical Application Circuit Evaluation Board Information

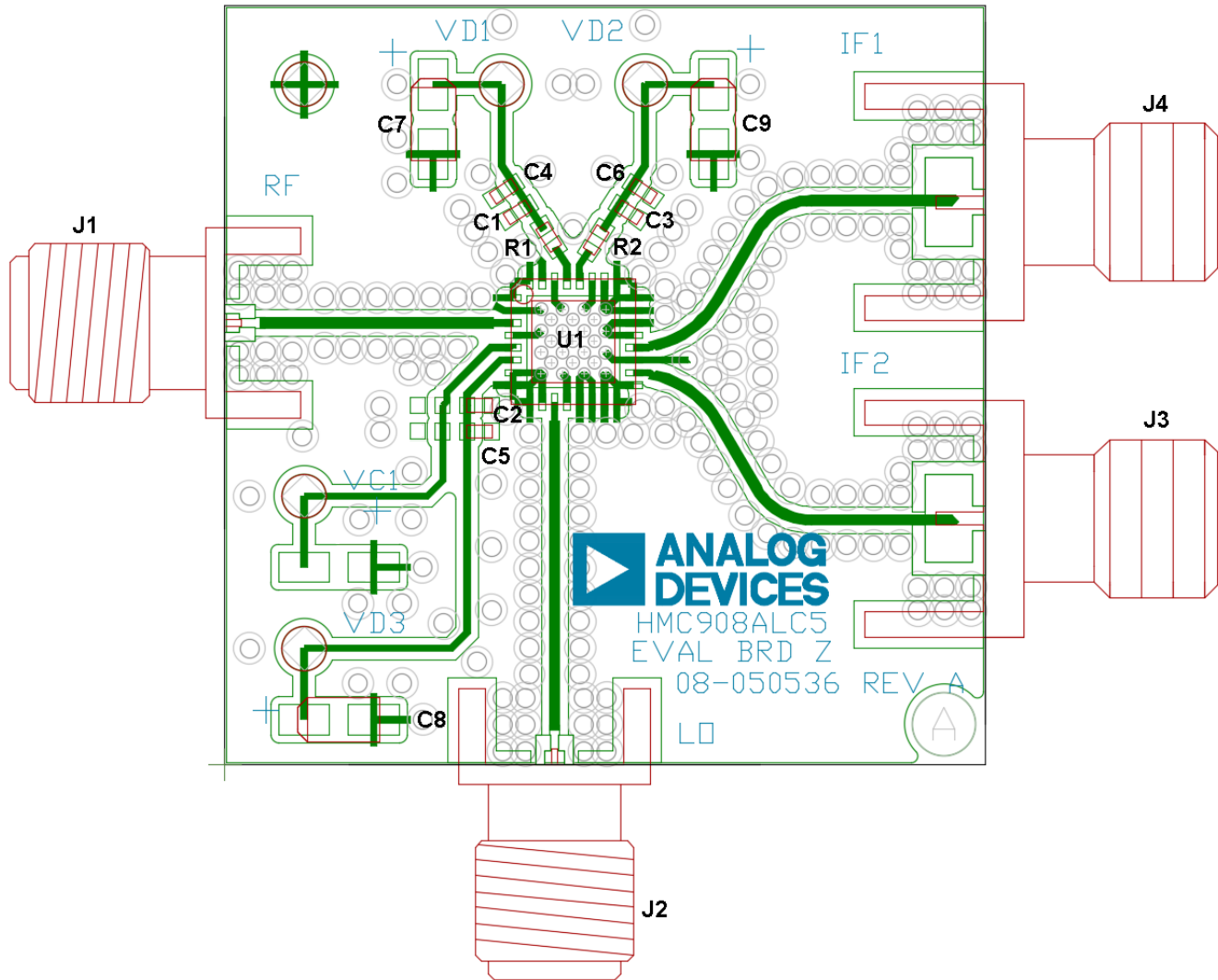

Figure 82. EV1HMC908ALC5 Evaluation PCB Top Layer

20070-081

Table 6. Bill of Materials for the EV1HMC908ALC5 Evaluation PCB

Reference Designator	Description
08-050536 ¹	Evaluation board, ² EV1HMC908ALC5.
J1, J2	PCB mount Subminiature Version A (SMA) RF connectors, SRI connector gage. J1 connects to RF, and J2 connects to LO.
J3, J4	PCB mount SMA connectors, Johnson SMA connectors. J3 connects to IF1, and J4 connects to IF2.
J5, J6, J7	DC Mill-Max pins. J5 connects to VD1, J6 connects to VD2, and J7 connects to VD3.
C1, C2, C3	100 pF capacitor, 0402 package.
C4, C5, C6	1000 pF capacitor, 0402 package.
C7, C8, C9	2.2 μF capacitor, Tantalum Case A.
R1, R2	0 Ω resistor, 0402 package.
U1	Device under test, HMC908A.

¹ 08-050536 is the raw bare PCB identifier. Reference EV1HMC908ALC5 when ordering the complete evaluation PCB.

² Circuit board RF material: 10 mils Rogers 4350.

PERFORMANCE AT LOWER IF FREQUENCIES

The HMC908A can operate at low IF frequencies approaching dc. Figure 83 shows the conversion gain and image rejection performance at lower IF frequencies.

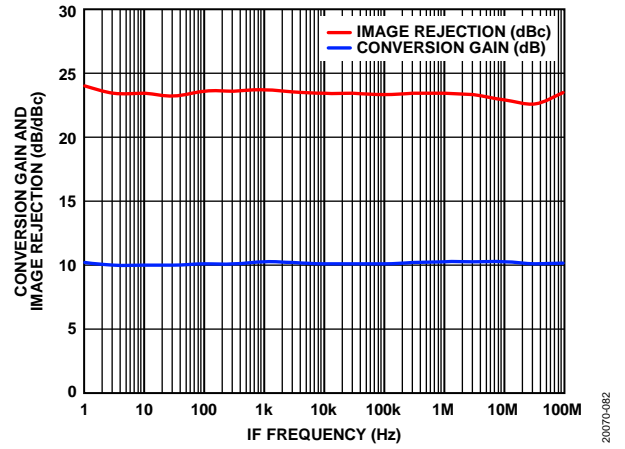

Figure 83. Conversion Gain and Image Rejection vs. IF Frequency at Low IF Frequencies, LO = 10.5 GHz at 0 dBm

OUTLINE DIMENSIONS

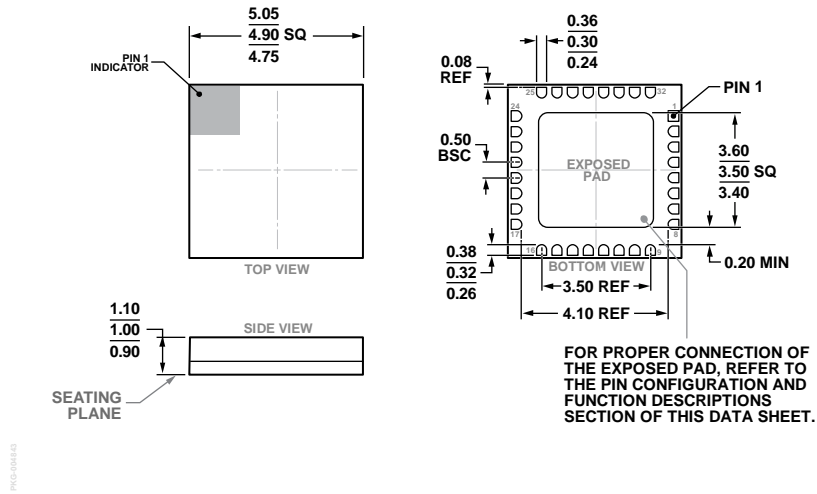

Figure 84. 32-Terminal Ceramic Leadless Chip Carrier (LCC)
(E-32-1)
Dimensions shown in millimeters

ORDERING GUIDE

Model ¹	Temperature Range	Package Body Material	Lead Finish	Package Description	Package Option
HMC908ALC5	-40°C to +85°C	Alumina Ceramic	Gold	32-Terminal Ceramic LCC	E-32-1
HMC908ALC5TR	-40°C to +85°C	Alumina Ceramic	Gold	32-Terminal Ceramic LCC	E-32-1
HMC908ALC5TR-R5	-40°C to +85°C	Alumina Ceramic	Gold	32-Terminal Ceramic LCC	E-32-1
EV1HMC908ALC5				Evaluation Board	

¹ All models are RoHS compliant parts.

Mouser Electronics

Authorized Distributor

Click to View Pricing, Inventory, Delivery & Lifecycle Information:

[Analog Devices Inc.:](#)

[HMC908ALC5](#) [HMC908ALC5TR](#) [HMC908ALC5TR-R5](#)